

20mm Edge Profiles

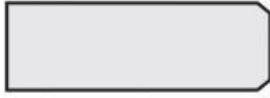

20mm Aris

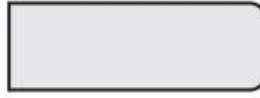

20mm Pencil Round



20mm Full Bullnose



20mm Half Bullnose

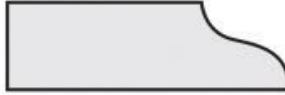

20mm Lambs Tongue

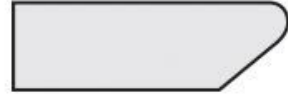

20mm Sharknose

40mm Edge Profiles

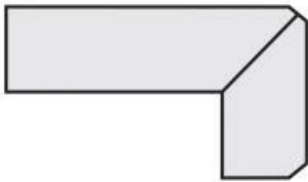

40mm Mitred Apron Aris

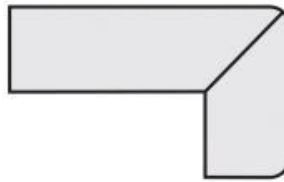

40mm Mitred Apron Pencil Round

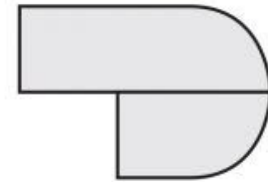

40mm Full Bullnose

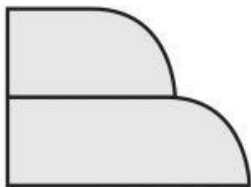

40mm Half Bullnose - Half Bullnose



40mm Half Bullnose - Full Bullnose



40mm Lambs Tongue

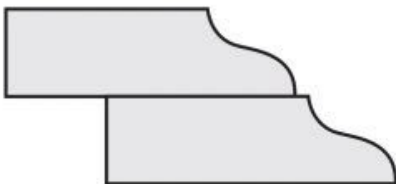

40mm Lambs Tongue - Lambs Tongue



40mm Lambs Tongue - Half Bullnose



40mm Lambs Tongue - Full Bullnose

Drawings are for illustration purposes only

60mm Edge Profiles

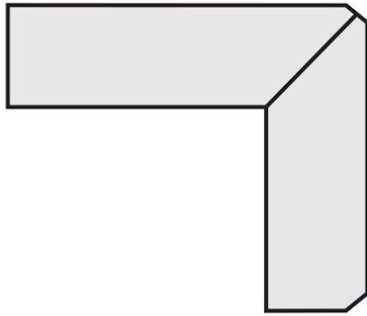

60mm Mitred Apron Aris

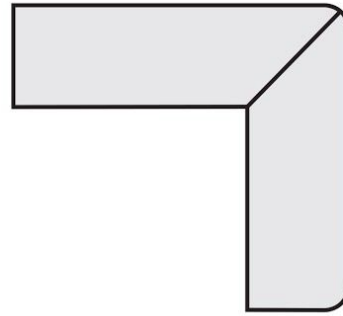

60mm Mitred Apron Pencil Round

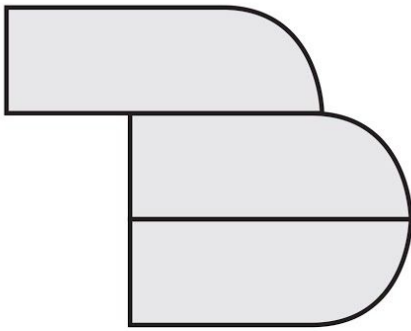

60mm Half Bullnose - Full Bullnose

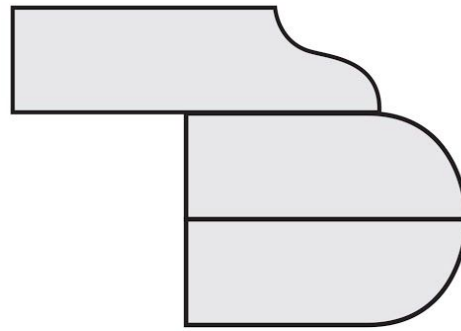

60mm Lambs Tongue - Full Bullnose

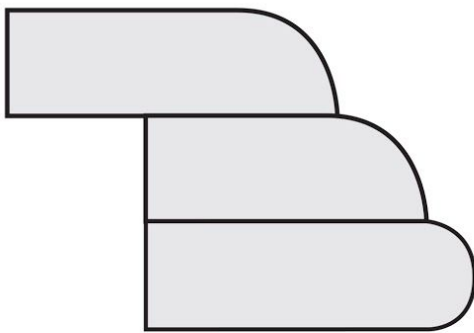

60mm Half Bullnose - Half Bullnose - Full Bullnose

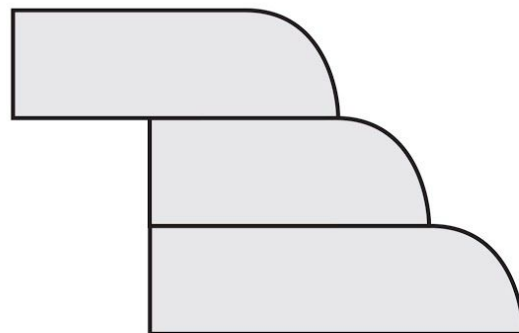

60mm Half Bullnose - Half Bullnose - Half Bullnose

Drawings are for illustration purposes only

60mm Edge Profiles

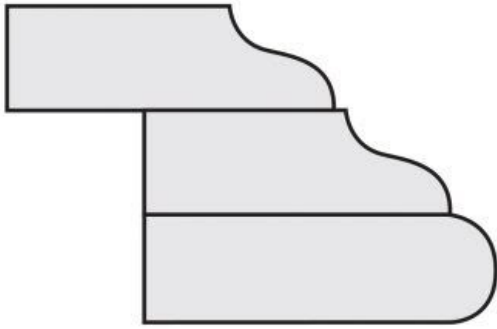

60mm Lambs Tongue - Lambs Tongue - Full Bullnose

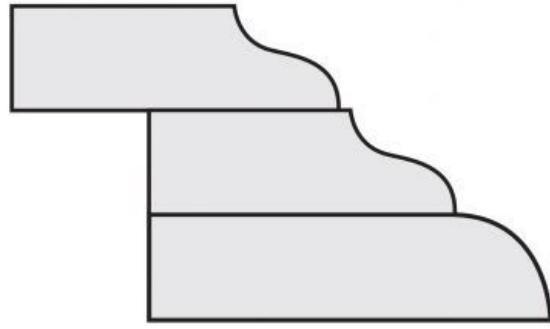

60mm Lambs Tongue - Lambs Tongue - Half Bullnose

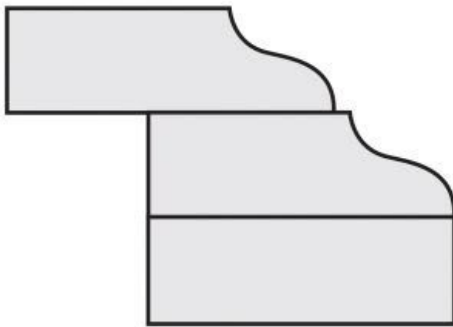

60mm Lambs Tongue - Lambs Tongue

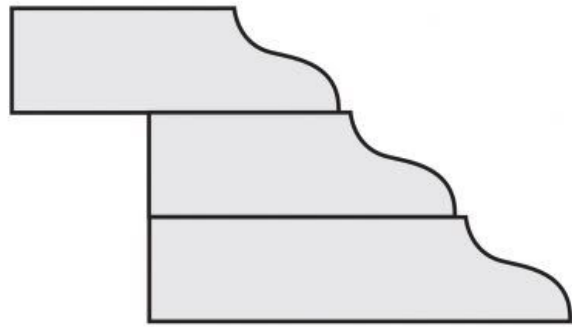

60mm Lambs Tongue - Lambs Tongue - Lambs Tongue

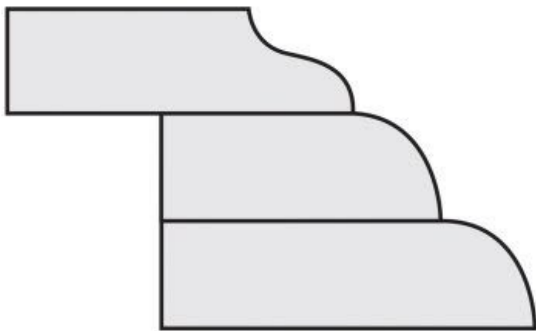

60mm Lambs Tongue - Half Bullnose - Half Bullnose

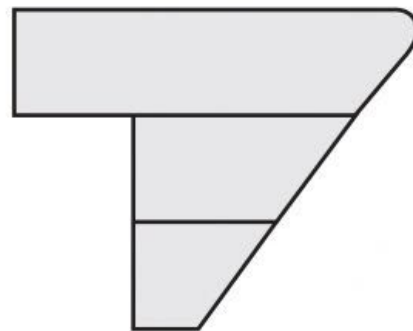

60mm Sharknose

Drawings are for illustration purposes only